

Auftragsnummer: AquaLOCK Tor	Werkstoff:	Datum: 20.12.2022
Zeichnungstitel: AquaLOCK-Tor	Oberfläche:	Name: D. Högerle
Kunde:	Schalung: Blech 3mm	 Maßstab: Blatt 1 1:16 von 2 A3

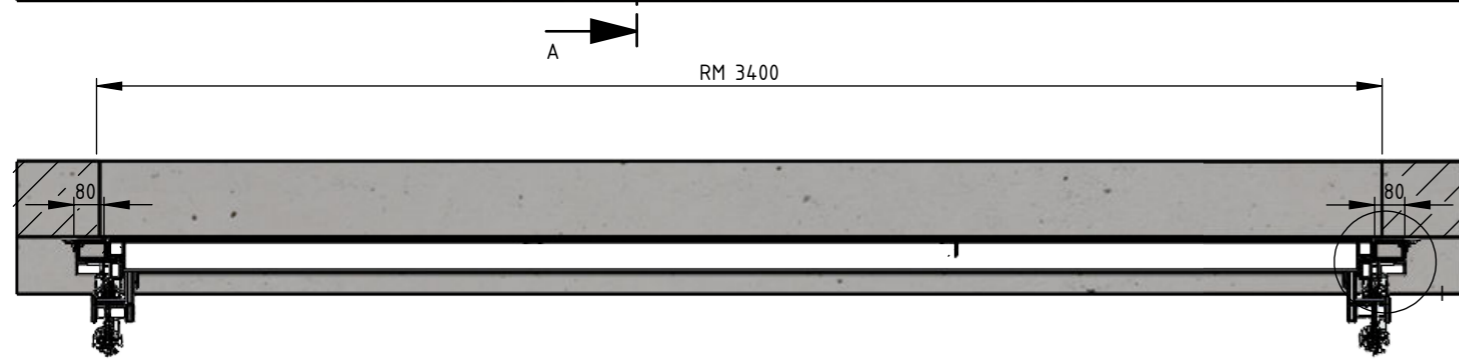

gleich wie Einbauluft
identique à dégagement d'installation
same as installation air
10

Dichtmasse
mastic d'étanchéité
sealant

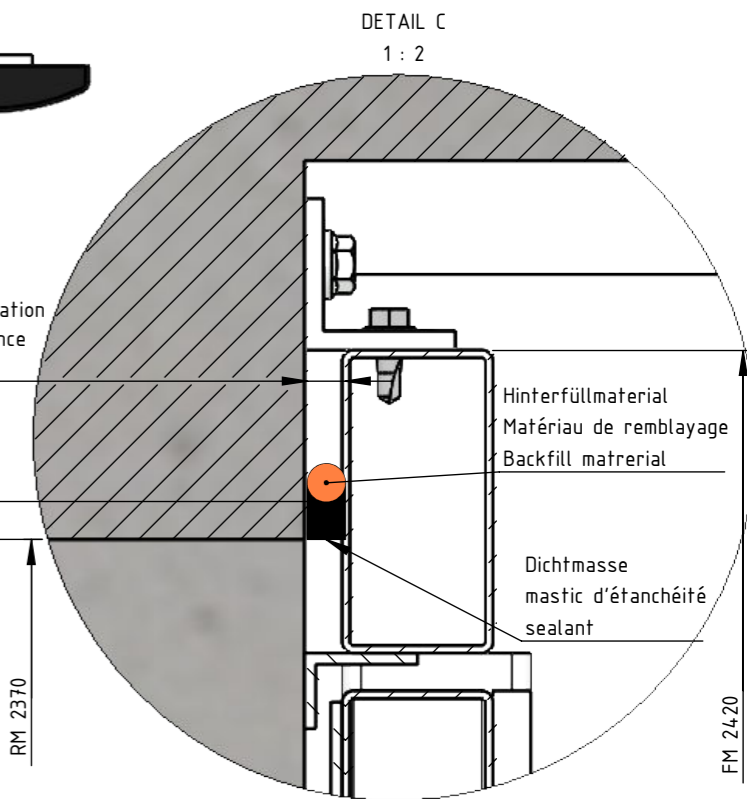
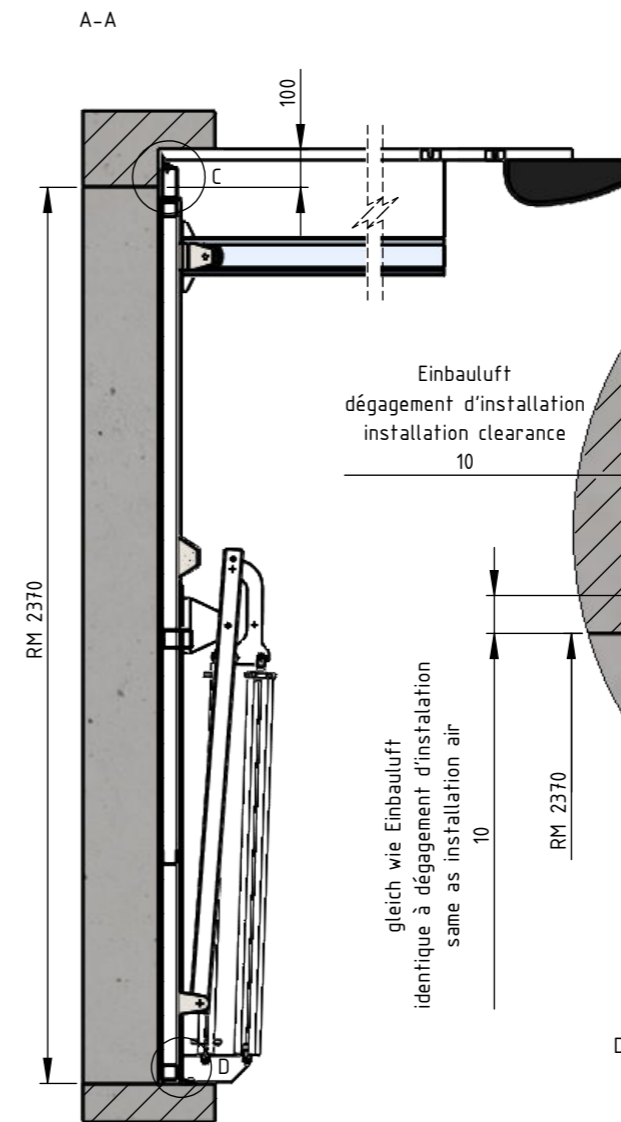
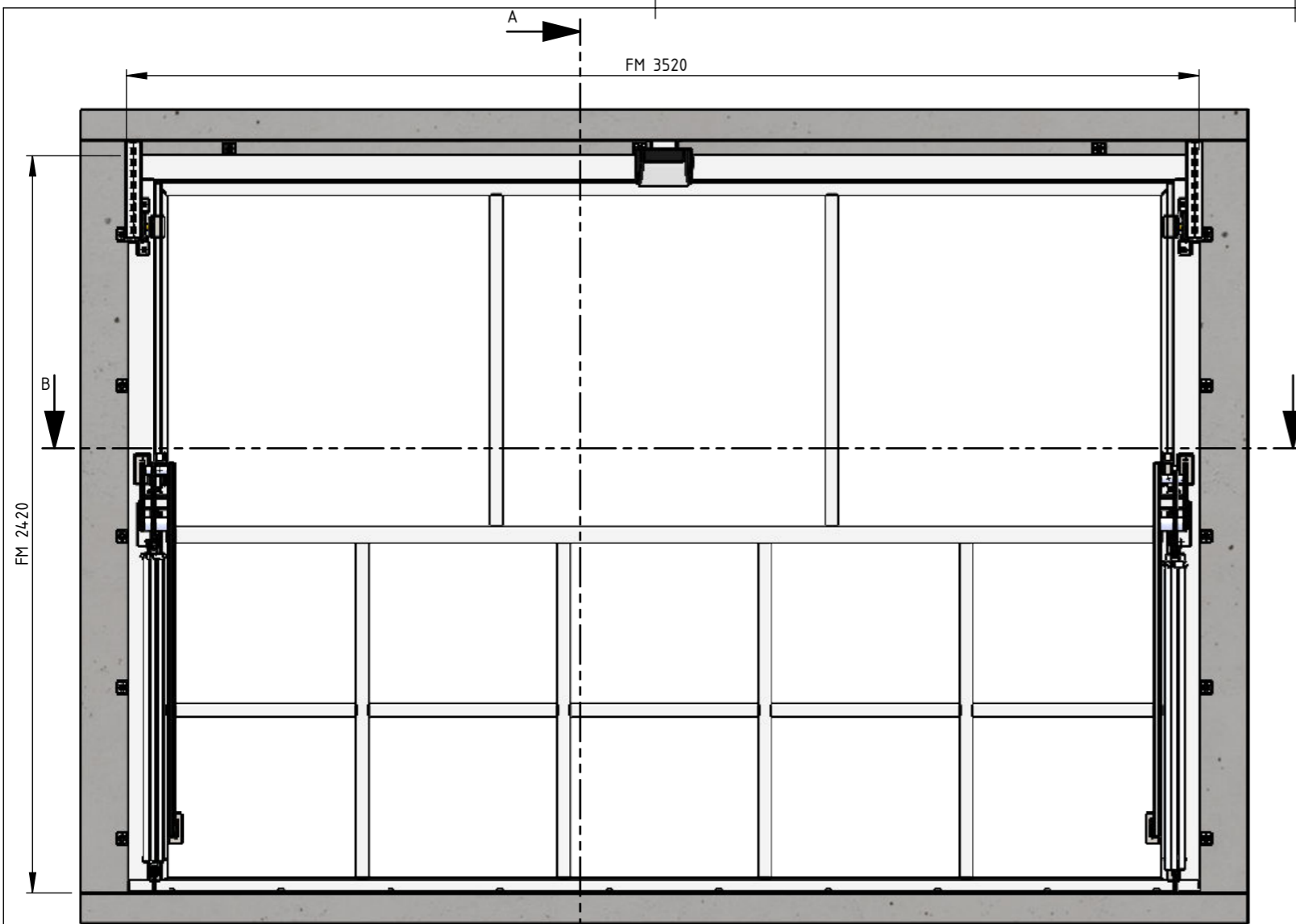
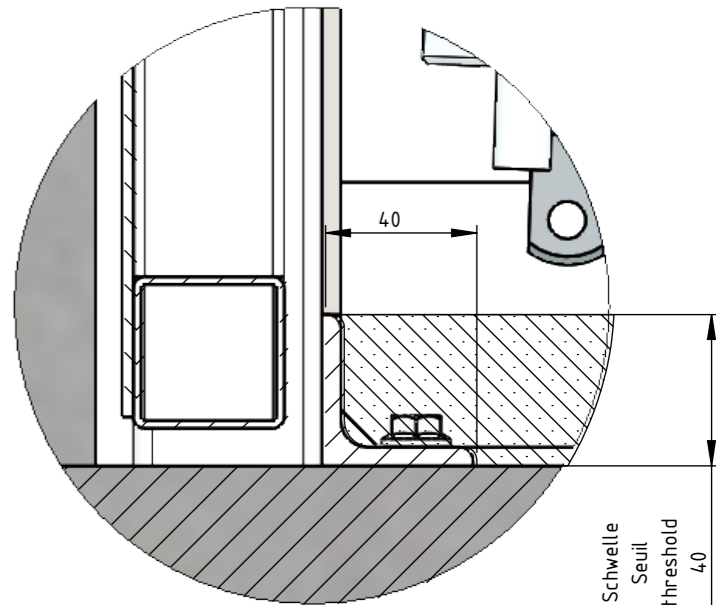
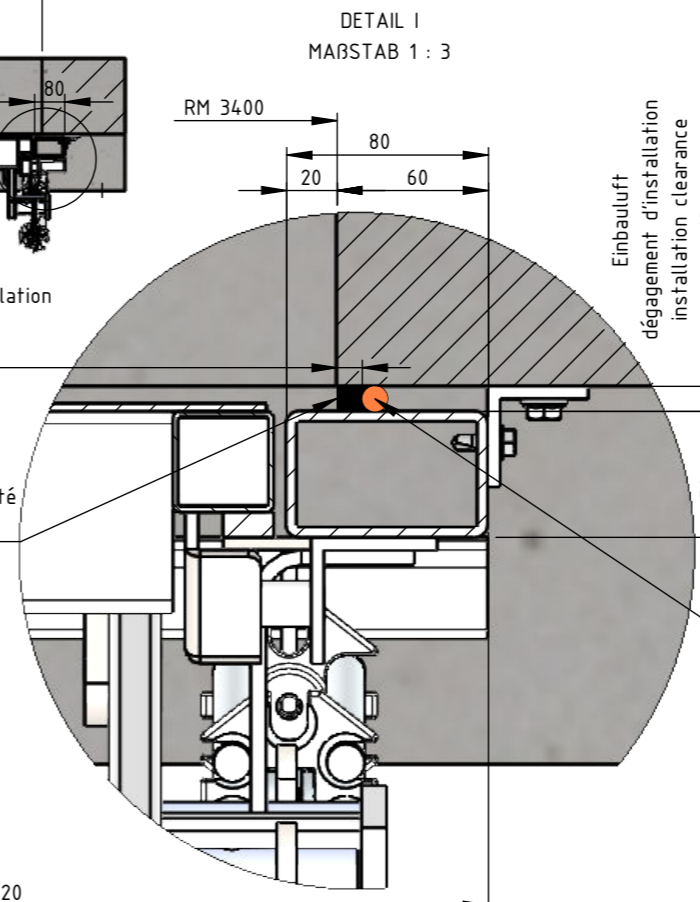

RM Öffnungsmaß / Bestellmaß
RM Dimension dd' ouvertur / dimension de commande
RM Opening dimension / ordering dimension

FM Außenmaß Stahlkonstruktion
FM Dimension extérieur en acier
FM Outer dimension steel construction

Auftragsnummer: AquaLOCK Tor	Werkstoff:	Datum: 20.12.2022
Zeichnungstitel: AquaLOCK-Tor	Oberfläche:	Name: D. Högerle
Kunde:	Schalung: Blech 3mm	 Maßstab: Blatt 2 1:20 von 2 A3